

# Water Treatment



## ATHENA MP

### ELECTROMAGNETIC DOSING PUMPS



## Main characteristics

- PVDF PUMP HEAD suitable for chemicals used in Industrial, Waste Water Treatment and Potable Water applications
- CERAMIC BALL full chemical compatibility
- PTFE DIAPHRAGM unique life expectancy and compatibility with most chemicals
- STEADY DOSING Stabilized Multi Power Supply 100÷240 Vac 50/60 Hz with reduced consumption
- QUICK CONNECTIONS
- MANUAL PRIMING VALVE
- IP65 PROTECTION
- ADJUSTABLE FLOW RATE
- POWER-ON and LEVEL ALARM LED
- DIGITAL PROPORTIONAL DOSING WITH INSTRUMENT FOR POTENTIOSTATIC SENSORS
- Able to set measurement for: chlorine, hydrogen peroxide, peracetic acid
- PT100 probe input for the automatic temperature compensation
- 4/20mA output for the measurement repetition
- Digital ON-OFF input for remote control
- Anti-seepage system

# Water Treatment



## Athena – Performance data

PERFORMANCES TEST HAS BEEN DONE AT AMBIENT TEMPERATURE, WITH WATER, AT 1,5 mt SUCTION HEIGHT

FLOW RATES	PRESSURES	CC/IMP.	CONNECTIONS	STROKES/MIN.	CONSUMPTION	WEIGHT	MODEL
2,5 l/h	20 bar	0,35	4x6 – 4x7	120	14 watt	3kg	<b>Athena 1</b>
3 l/h	18 bar	0,42	4x6 – 4x7	120	14 watt	3 kg	
4,2 l/h	14 bar	0,58	4x6 – 4x7	120	14 watt	3 kg	
7 l/h	8 bar	0,97	4x6 – 4x7	120	14 watt	3 kg	
3 l/h	12 bar	0,31	4x6	160	20 watt	3 kg	<b>Athena 2</b>
4 l/h	10 bar	0,42	4x6	160	20 watt	3 kg	
5 l/h	8 bar	0,52	4x6	160	20 watt	3 kg	
8 l/h	2 bar	0,83	4x6	160	20 watt	3 kg	
7 l/h	16 bar	0,39	4x6	300	40 watt	4 kg	<b>Athena 3</b>
10 l/h	10 bar	0,56	4x6	300	40 watt	4 kg	
15 l/h	5 bar	0,83	4x6	300	40 watt	4 kg	
18 l/h	1 bar	1,00	4x6	300	40 watt	4 kg	
20 l/h	5 bar	1,11	8x12	300	40 watt	4 kg	<b>Athena 4</b>
32 l/h	4 bar	1,78	8x12	300	40 watt	4 kg	
62 l/h	2 bar	3,44	8x12	300	40 watt	4 kg	
110 l/h	0,1 bar	6,11	8x12	300	40 watt	4 kg	

# Water Treatment

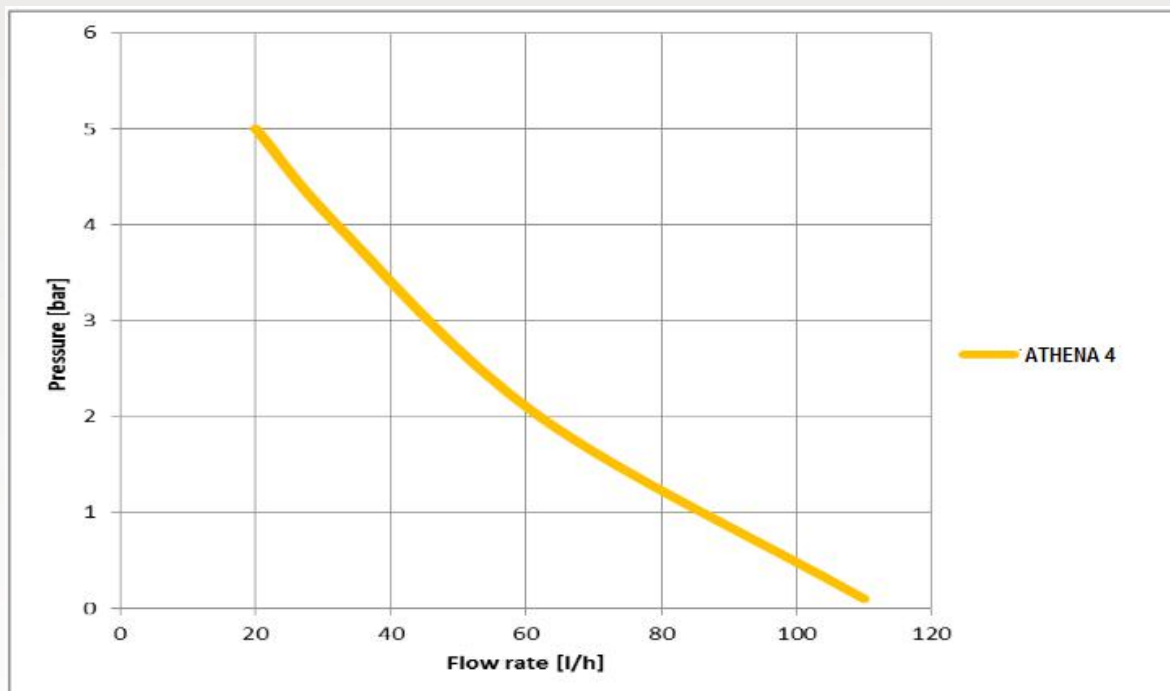
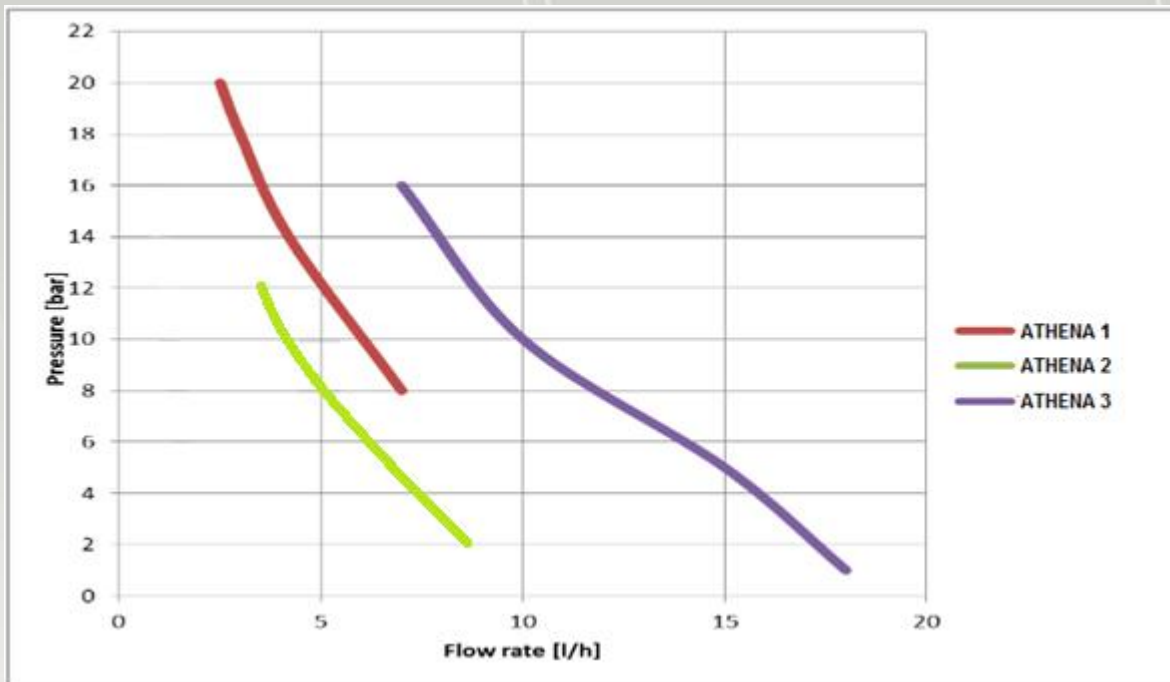

# Water Treatment



## Anti-seepage system

The anti-seepage system, is a solution to prevent the intrusion of chemical product inside the pump: leakage and chemical intrusion can happen when the O-ring is damaged or consumed by regular use.

This device is integrated in the hydraulic part, between pump head and body, behind the diaphragm: the outgoing collection channel of the anti-seepage device (see below blue arrow) collects the leakage and expel it out.

When the leakage is visible, the operator can proceed either tightening the 4 bolts of the head (4Nm torque) or disassembling the head and inspect it in order to understand leakage causes .

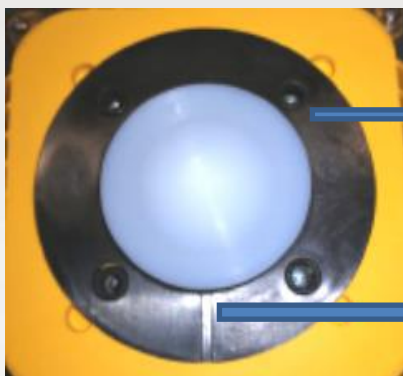

→ Anti-seepage device

→ collection channel

# Water Treatment



## Main applications

- Electroplating industry, Pickling, Degreasing and metal treatment
- Cooling Tower
- Potable water
- Reverse osmosis
- Paper industry
- Ceramic industry

## Example of installation

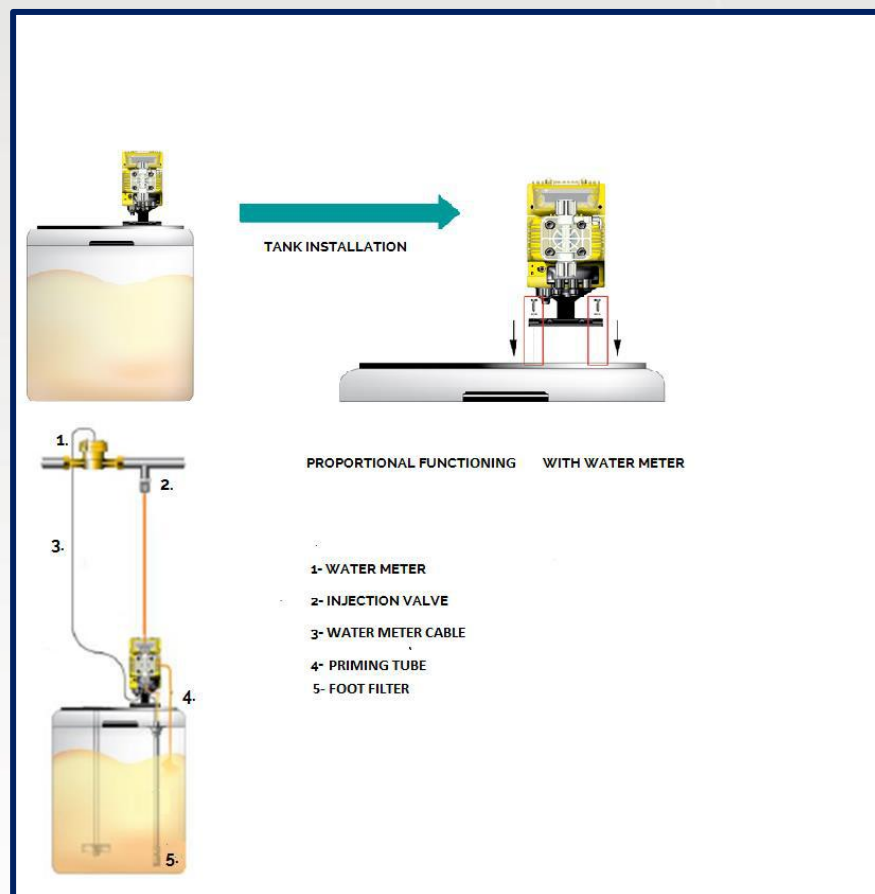



# Water Treatment

## Installation kit





## Accessories

<b>AC.VSA (ATHENA.1 .2 .3)</b>	
	<ul style="list-style-type: none"> <li>• PvdF Pump head with automatic bleed valve</li> <li>• Flow reduction, according to the quantity of air in the liquid</li> </ul>

<b>AC.VM PVDF</b>	
	<ul style="list-style-type: none"> <li>• Multifunction valve, antisiphon, backpressure, safety</li> <li>• PVDF body, PTFE membrane</li> <li>• Adjustable Pressure 0-5 bar • Relief Pressure 0-18 bar</li> </ul>

<b>AC.SF</b>	
	<ul style="list-style-type: none"> <li>• Flow sensor</li> <li>• FPM Seals</li> <li>• 4x6 / 8x12 connections</li> </ul>

<b>AC.SL</b>	
	<ul style="list-style-type: none"> <li>• Floating level probe with bipolar cable (2 mt) with support</li> </ul>

<b>AC.VIE</b>	
	<ul style="list-style-type: none"> <li>• Extractable injection valve PVC 1/2" g.m. IN - 1/2" g.m. OUT</li> </ul>
	<ul style="list-style-type: none"> <li>• Extractable injection valve with ball valve PVC 1/2" g.m. IN - 1/2" g.m. OUT</li> </ul>

<b>PRIMING AID</b>	<b>Capacity</b>
	<ul style="list-style-type: none"> <li>• Capacity: 300 ml</li> <li>• PVC Body</li> <li>• FPM seals</li> <li>• Connection: 4x6mm-8x12mm</li> </ul>

<b>AC.ST</b>	
	<ul style="list-style-type: none"> <li>• Horizontal base mounting bracket</li> </ul>

<b>AC.VS</b>	
	<ul style="list-style-type: none"> <li>• Back-pressure valve up to 10 bar</li> <li>• PTFE diaphragm</li> </ul>

# Water Treatment



## Dimensional drawings

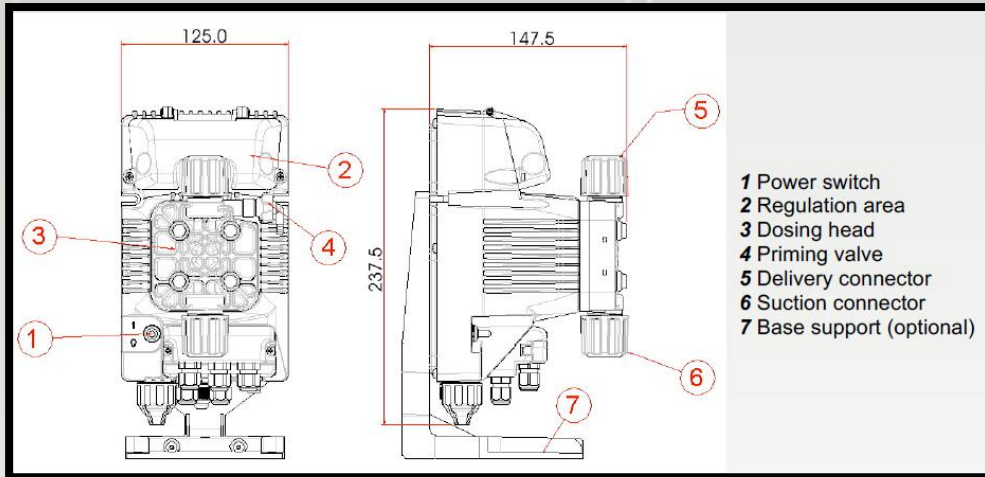

## Plumbing

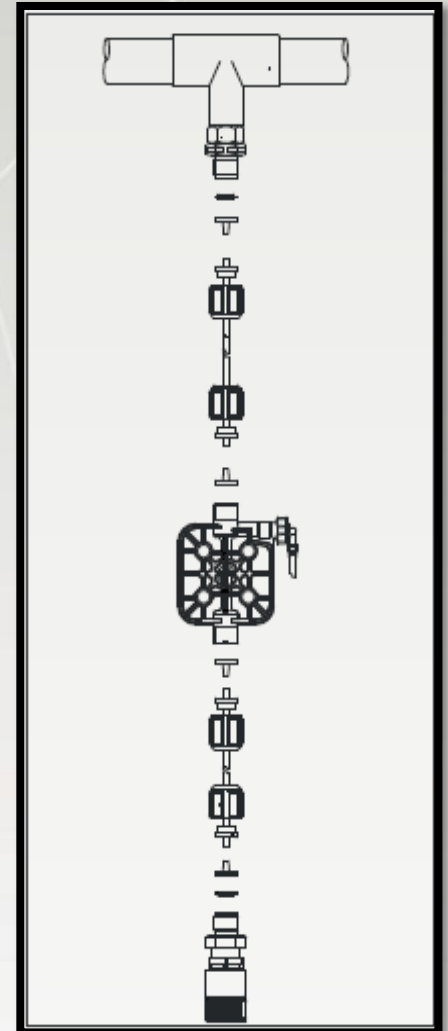

## Fixing templates

